

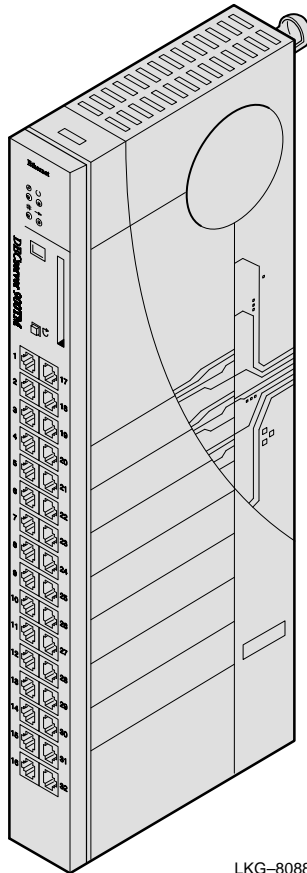

## DECserver 900TM INSTALLATION



LKG-8088-931

### DECserver 900TM

The DECserver 900TM is a 32-port network access server that connects asynchronous devices, including terminals, printers, modems, or PCs to an Ethernet local area network (LAN). It operates in a DEChub 900 MultiSwitch or as a standalone access server. The DECserver 900TM is configured with 32 MJ8 (RJ-45) connectors, and provides limited modem control with the 8-pin connectors. Each port supports 16 baud rates from 75 baud to 115.2 Kbaud. The DECserver 900TM includes 4 megabytes (MB) of standard memory, and can be expanded to 8 MB.

**EK-DSRVZ-IN. A01**

## Copyright

EK-DSRVZ-IN. A01  
August 1993

The information in this document is subject to change without notice and should not be construed as a commitment by Digital Equipment Corporation. Digital Equipment Corporation assumes no responsibility for any errors that may appear in this document.

Copyright © 1993 by Digital Equipment Corporation  
All Rights Reserved.  
Printed in U.S.A.

\*\*\*

The following are trademarks of Digital Equipment Corporation:

DEC, DECconnect, DEChub, DEChub ONE, DECserver, Digital, MultiSwitch, ULTRIX, OpenVMS, and the Digital logo.

\*\*\*

UNIX is a trademark of UNIX System Laboratories, Inc.

**FCC NOTICE** – Class A Computing Device:

This equipment generates, uses, and may emit radio frequency energy. The equipment has been type tested and found to comply with the limits for a Class A computing device pursuant to Subpart J of Part 15 of FCC Rules, which are designed to provide reasonable protection against such radio frequency interference when operated in a commercial environment. Operation of this equipment in a residential area may cause interference; in which case, measures taken to correct the interference are at the user's expense.

\*\*\*

**VCCI NOTICE** – Class 1 Computing Device:

This equipment is in the 1st Class category (information equipment to be used in commercial and/or industrial areas) and conforms to the standards set by the Voluntary Control Council for Interference by Data Processing Equipment and Electronic Office Machines aimed at preventing radio interference in commercial and/or industrial areas.

Consequently, when used in a residential area or in an adjacent area thereto, radio interference may be caused to radios and TV receivers.

Read the instructions for correct handling.

## Front Panel

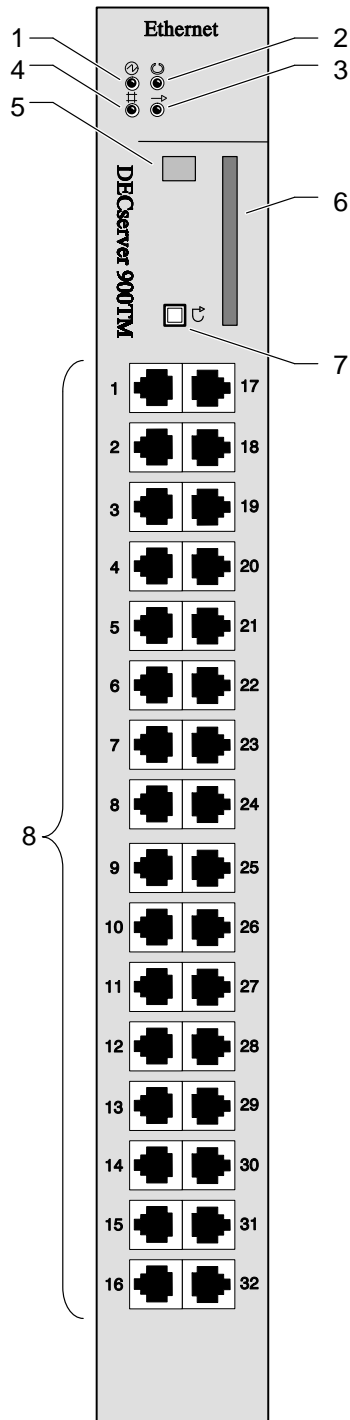

- 1) **Power LED.** Lights when the module has power.
- 2) **Module OK LED.** Lights when the module passes self-test. Flashes when a non-fatal error occurs on self-test. If the module fails self-test, the Module OK LED is off.
- 3) **Network Traffic.** Flashes or remains on depending on network activity.
- 4) **Network OK.** Lights when the module has an active network connection.
- 5) **Seven-Segment Display.** Provides error and status information.
- 6) **Flash RAM Slot.** Provides an opening in which to insert the Flash RAM card.
- 7) **Reset Switch.** Resets the module to factory defaults. To reset: while turning on the power, press and hold the reset switch until the Module OK LED flashes; or if the DECserver 900TM is in operational mode (the seven segment display shows the "race track" pattern), hold the switch in for 5 seconds. The module reboots with factory defaults.
- 8) **Serial Port Connectors.** Connect the asynchronous devices to the DECserver 900TM. The serial port connectors are labeled 1 to 32.

LKG-8089-931

## Installing the Module into a DEChub 900 MultiSwitch

You do not have to shut off the DEChub 900 MultiSwitch power when you install a module in the hub. The DECserver 900TM has a built-in hot-swap switch that allows quick and easy power-on installation and removal.

- 1** Install the module into the DEChub 900 MultiSwitch.
  - a. Check the Hub Manager Status Display to ensure that there is adequate power in the DEChub 900 MultiSwitch to accommodate this module's power rating. You may have to add another power supply to the DEChub 900 MultiSwitch to accommodate this module without affecting other modules already in the hub.
  - b. Locate an available DEChub slot.
  - c. Place the module's bottom mounting tab into the mounting slot on the hub.
  - d. Pivot the module on the mounting tab and align the connectors. You hear the release lever click when the module is seated.
  - e. Press down on the release lever to ensure that it is locked.
  - f. Seating the module initiates the power up sequence and self-test within 10 seconds if the available DEChub power is sufficient. Read the Hub Manager Status Display for the module status and power consumption.

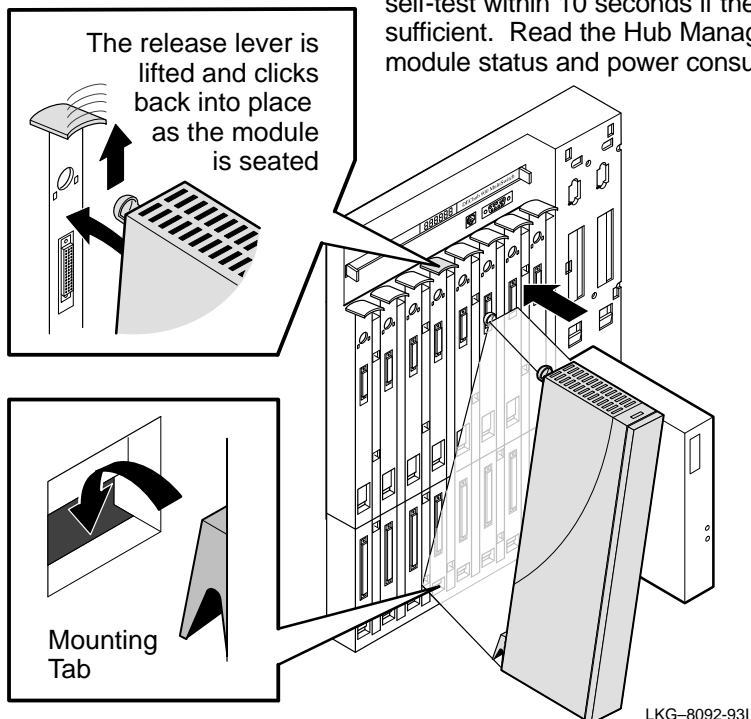

## Installing the Module in a DEChub 900 MultiSwitch (continued)

### 2 Verify power.

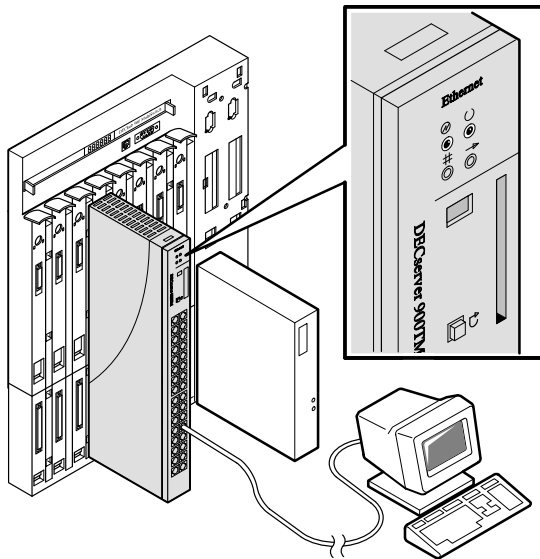

LKG-8091-931

- a. With power on in the DEChub, verify that the Power LED is on.
- b. Verify that the Module OK LED remains on after the module completes self-test.

### 3 Connect the port cables.

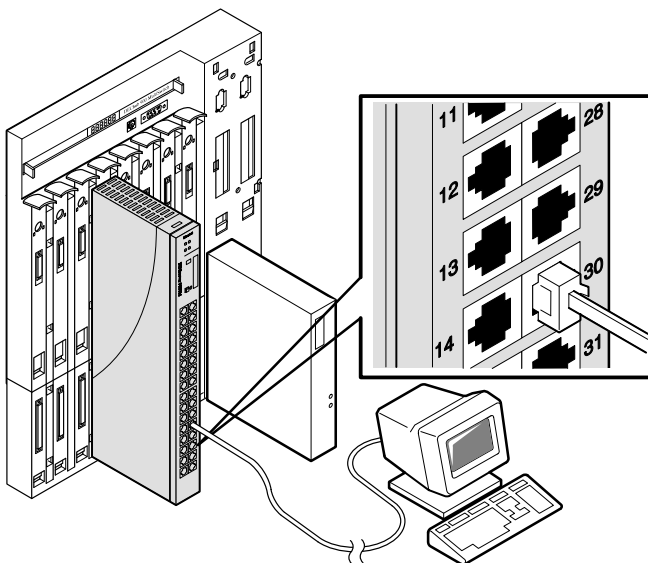

LKG-8090-931

Connect the port cables to any available port connector on the module.

#### Notes:

Port 1 by default may be used as a console port.

The DECserver 900TM does not support the out-of-band management (OBM) port or the setup port on the DEChub ONE. No devices should be connected to these ports.

Module installation is complete.

## Installing Flash RAM

If you are using a Flash RAM card for loading the operational software, perform the following:

- 1** Insert the Flash RAM card into the Flash RAM slot on the front of the module.
  - a. The Digital label should be on the same side as the DECserver 900TM logo on the front panel of the module.
  - b. When properly inserted, the Flash RAM card protrudes from the front panel about 1/4 inch. The Flash RAM card is keyed and cannot be inserted improperly.

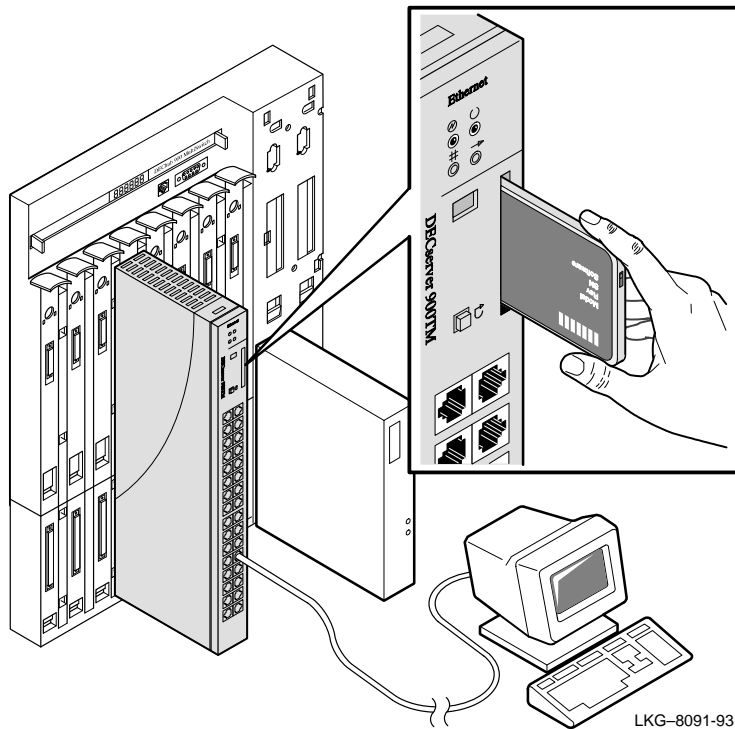

The Flash RAM card can be hot swapped and may be inserted or removed at anytime. If you are booting from the Flash RAM card, insert it before powering the module or during the self-test phase.

Once you boot the DECserver 900TM, the card may be left in place or removed.

## Removing the Module from the DEChub 900 MultiSwitch

- 1** Disconnect the port connector cables from the module.
  
- 2** Remove the module from the DEChub.
  - a. Lift the release lever on top of the hub slot.
  - b. Pivot the module back on its bottom mounting tab until it disengages from the hub.

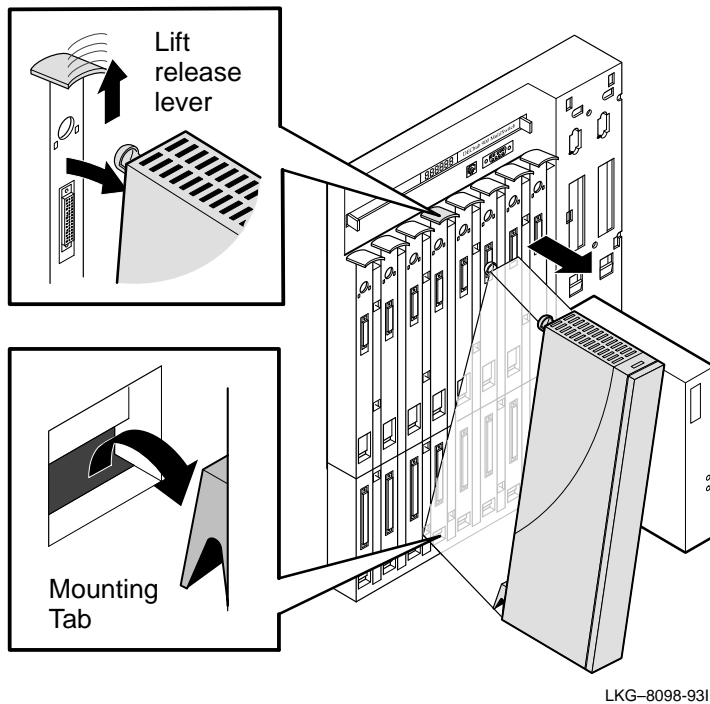

## Cabling

Table 1 shows the maximum cable lengths for a number of data rates using DECserver 900TM supported line protocols.

For more information about cabling and configuring of local area networks (LANs) and using DECconnect system products, refer to the *DECconnect System Planning and Configuration Guide*.

**Table 1 Maximum Cable Lengths<sup>1</sup> -- DECserver 900TM to Devices**

Line Protocol	Data Rate (Baud)	Cable Length
EIA-432-A/V1.0	4.8 K	500 m (1600 ft)
	9.6 K	280 m (900 ft)
	19.2 K	150 m (500 ft)
	38.4 K	85 m (280 ft)
	57.6 K	30 m (100 ft)
	115.2 K	12 m (40 ft)
DEC 423	9.6 K	900 m (3000 ft)
	19.2 K	300 m (1000 ft)
	38.4 K	150 m (500 ft)
	57.6 K	60 m (200 ft)
	115.2 K	30 m (100 ft)
EIA-232-E/V.28	9.6 K	60 m (200 ft)
	19.2 K	30 m (100 ft)
	38.4 K	15 m (50 ft)
	57.6 K	6 m (20 ft)
	115.2 K	3 m (10 ft)

<sup>1</sup> For cable type H8245-A or H8246-B, 24 AWG, 4 pair, twisted pair.



## Cabling (continued)

Before connecting cables to the DECserver 900TM ports, you must verify supported modem signals with the person managing the DECserver 900TM. This information is necessary to determine what cables to use. For more information on the signals, refer to the *Network Access Server Management* manual.

Table 2 describes the cable connections that are compatible with the DECserver 900TM Ethernet and serial line connectors. Wiring diagrams of individual cables are shown on page 11.

**Table 2 Cable Connections Compatible with the DECserver 900TM**

Cable Type	Description
H8585-AC <sup>1</sup> MJ8 to DB25 (male) modem adapter	Use this adapter with the BN25G cable to connect high-speed modems to the DECserver 900TM.
H8585-AB <sup>1</sup> MJ8 to DB25 (male) modem adapter	Use this adapter with the BN25G cable to connect low-speed modems to the DECserver 900TM.
H8585-AA MJ8 to DB9 (female) null-modem adapter	Use this adapter with the BN25G cable to convert the DECserver 900TM connector to the DB9 connector for cabling to PC asynchronous ports.
H8584-AC MP8 to MMJ adapter	Use this adapter to convert a serial port to a DECserver 300 terminal server configuration.
BN24H MP8 to MP6 office cable	Use this office cable to connect from the 6-pin MMJ port of a terminal or printer to the 8-pin MJ faceplate data connector. The BN24H is configured with one 6-pin modified modular plug, one standard 8-pin plug, and crossover wiring.
BN25G MP8 to MP8 equipment cable	Use this cable as either a patch cord or office cable. It is configured with standard 8-pin modular plugs, which connect four unshielded twisted pairs pin-to-pin.

<sup>1</sup>Adapters H8585-AB and H8585-AC are not for connection to public works in Sweden, Germany, or Japan.

## Cabling (continued)

The DECserver 900TM uses an MJ8 connector on the serial ports, and can be configured by the software to support the pin signals indicated in Table 3.

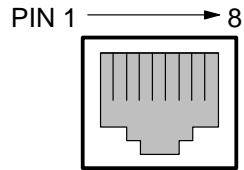

**Table 3 DECserver 900TM Serial Line Ports**

Pins	1	2	3	4	5	6	7	8
Signal Name	RXD GND	RXD	TXD GND	CTS or RI (Selected by software)	RTS or DSRS (Selected by software)	TXD	DTR	DSR or DCD (Selected by software)
Software Default <sup>1</sup>	RXD GND	RXD	TXD GND	CTS	RTS	TXD	DTR	DSR
Software Alternative <sup>1</sup>	RXD GND	RXD	TXD GND	RI	DSRS	TXD	DTR	DCD

<sup>1</sup> To change default values, refer to the *Network Access Server Management* manual.

## Cabling (continued)

The following wiring diagrams illustrate the cable connections that are compatible with the DECserver 900TM Ethernet and serial line connectors:

**H8585-AC MJ8 to DB25 Modem Adapter**

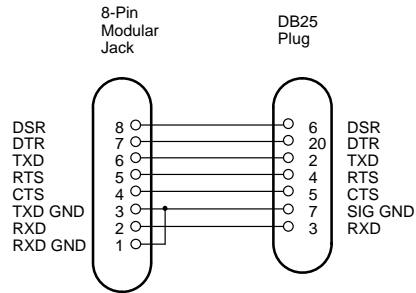

**H8585-AB MJ8 to DB25 Modem Adapter**

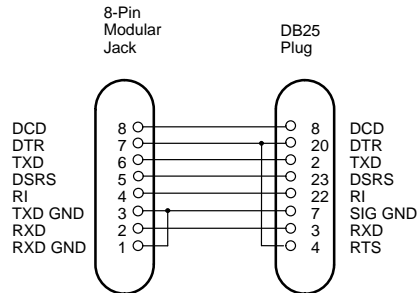

**H8585-AA MJ8 to DB9 Null-Modem Adapter**

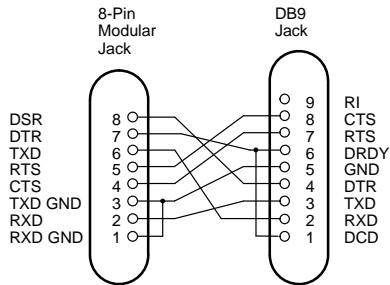

**H8584-AC MP8 to MMJ Adapter**

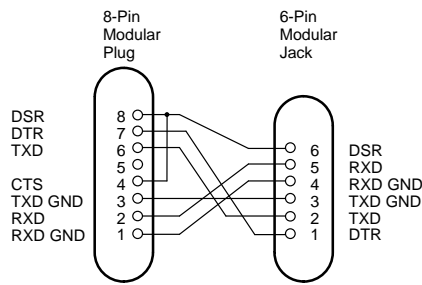

**BN24H MP8 to MP6 Office Cable**

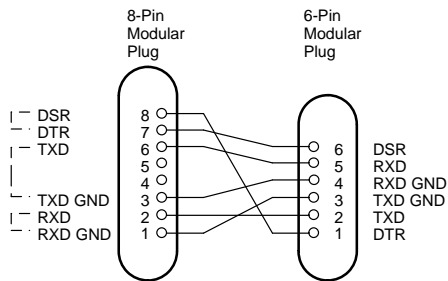

--- Twisted pairs

**BN25G MP8 to MP8 Equipment Cable**

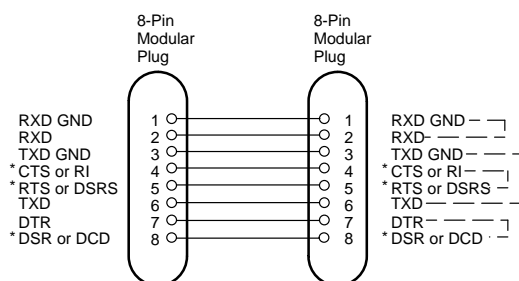

\*Software selectable

--- Twisted pairs

LKG-7294-921

## Problem Solving

If ...	Then ...	Do This ...
Power LED is off.	Module does not have power.	Verify that the outlet has power. Check the power connection to the server. Replace the power supply. Replace the module.
Module OK LED is off.	Fatal error.	Return the the unit to Digital Equipment Corporation.
Module OK LED is flashing.	Non-fatal error.	See the error message on the console port.
Seven-segment display is flashing "C," "d," or "n."	Memory failure.	Return the unit to Digital Equipment Corporation.
Seven-segment display is flashing.	Fatal error.	Return the unit to Digital Equipment Corporation.
Seven-segment display shows a "3."	Downline loading problem exists.	See the error message on the console port.

## Problem Solving (continued)

This section shows the codes that appear on the seven-segment display during the server internal self-test when the module goes through a power up and initialization. The first column indicates a horizontal view (standalone). The second column indicates a vertical view (hub) of the codes. The third column describes the codes.

Off	Off	No power or display broken
8	8	Initial power on
F	F	Initialization
E	E	DECserver 900 internal test
d	P	SIM 1 test
[	]	SIM 2 test
b	b	DECserver 900 internal test
A	A	DECserver 900 internal test
9	9	DECserver 900 internal test
7	L	DECserver 900 internal test
S	S	Network interface external test
≡	≡	Software loading from Flash RAM
4	4	Requesting load
3	E	Load request backoff
2	2	Loading
1	1	Requesting dump
0	0	Dumping
H	H	Hardware revision # incompatible with firmware revision #
∩	∩	No SIMs, or wrong type SIMs installed
Rotating	Rotating	DECserver 900 is operating correctly. The rotating code is referred to as the "race track" pattern.

LKG-8099-93I

## MIBs and RFCs

### Obtaining RFCs and Digital Private MIBs: Using ftp

You can obtain Requests for Comments (RFCs) and up-to-date DEChub Management Information Base (MIBs) from Digital using anonymous ftp.

Digital offers Internet anonymous ftp access to private MIB information, in ASCII text form, at `GATEKEEPER.DEC.COM`, with up-to-date documents stored in the directory `/private/mib`. Check the index file and the `readme` file for the current contents. To use anonymous ftp to copy files, follow these instructions:

1. Use the Internet application `ftp` to connect to `gatekeeper.dec.com` (the Internet address is 16.1.0.2).
2. Log in as user `anonymous`.
3. Use your electronic mail address as the password.
4. Use the `cd` command to get to the directory `/private/mib`
5. Use the `ascii` command to specify that you are retrieving ASCII text files.
6. Use the `get` command to get the file or files that you require.
7. When you are finished, use the `quit` command to log out.

Note that user input is case sensitive; you must type it as shown (user input is shown in **boldface** type).

Here is an example of copying the `readme` file from the repository.

```
% ftp gatekeeper.dec.com
Connected to gatekeeper.dec.com
220 GATEKEEPER.DEC.COM FTP Service Process
Name: anonymous
331 ANONYMOUS user ok, send real ident as password.
Password: milano@netman.stateu.edu
230 User ANONYMOUS logged in at Tue 10-Aug-1993 10:24-EST, job 54.
ftp> cd /private/mib
331 Default name accepted. Send password to connect to it.
ftp> ascii
220 Type A ok.
ftp> get readme
200 Port 19.54 at host nnn.nn.nn.nn accepted.
150 ASCII retrieve of /PRIVATE/MIB/README started.
226 Transfer completed. 40239 (8) bytes transferred.
40239 bytes received in 23.65 seconds (5.8 Kbytes/s)
ftp> quit
%
```

## Product Specifications

Product Specification	DECserver 900TM	DEChub ONE Server 900TM																		
Height	44.45 cm (17.5 in)	44.45 cm (17.5 in)																		
Width	4.45 cm (1.75 in)	4.45 cm (1.75 in)																		
Depth	5.25 cm (6 in)	25.4 cm (10.0 in)																		
Weight	1.8 kg (4 lb)	3.4 kg (7.5 lb)																		
Operating temperature <sup>1</sup>	5° C to 50° C (41° F to 122° F)	5° C to 50° C (41° F to 122° F)																		
Relative humidity	10% to 95% non-condensing	10% to 95% non-condensing																		
Altitude	Sea level to 4900 m (16,000 ft)	Sea level to 4900 m (16,000 ft)																		
Power	20W @+5Vdc, 7W@ +15Vdc	20W @+5Vdc, 7W@ +15Vdc																		
Connectors	Shielded RJ-45	Shielded RJ-45																		
Certification	CE, CSA, FCC, TÜV, UL, VCCI, VDE	CE, CSA, FCC, TÜV, UL, VCCI, VDE																		
Acoustics: Declared values per ISO 9296 and ISO 7779 <sup>2</sup>	<table border="0"> <thead> <tr> <th colspan="2">Idle/Operate</th> </tr> <tr> <th>Sound Power Level L<sub>WAd</sub>, B</th> <th>Sound Pressure Level L<sub>pAm</sub>, dBA</th> </tr> </thead> <tbody> <tr> <td>DSRVZ</td> <td>4.7</td> </tr> <tr> <td>DSRVZ + DEHUM</td> <td>—</td> </tr> </tbody> </table>	Idle/Operate		Sound Power Level L <sub>WAd</sub> , B	Sound Pressure Level L <sub>pAm</sub> , dBA	DSRVZ	4.7	DSRVZ + DEHUM	—	<table border="0"> <thead> <tr> <th colspan="2">Idle/Operate</th> </tr> <tr> <th>Sound Power Level L<sub>WAd</sub>, B</th> <th>Sound Pressure Level L<sub>pAm</sub>, dBA</th> </tr> </thead> <tbody> <tr> <td>—</td> <td>—</td> </tr> <tr> <td>5.1</td> <td>37</td> </tr> </tbody> </table>	Idle/Operate		Sound Power Level L <sub>WAd</sub> , B	Sound Pressure Level L <sub>pAm</sub> , dBA	—	—	5.1	37		
Idle/Operate																				
Sound Power Level L <sub>WAd</sub> , B	Sound Pressure Level L <sub>pAm</sub> , dBA																			
DSRVZ	4.7																			
DSRVZ + DEHUM	—																			
Idle/Operate																				
Sound Power Level L <sub>WAd</sub> , B	Sound Pressure Level L <sub>pAm</sub> , dBA																			
—	—																			
5.1	37																			
Schallemissionwerte: Wertangaben nach ISO 9296 und ISO 7779/DIN	<table border="0"> <thead> <tr> <th colspan="2">Leerlauf/Betrieb</th> </tr> <tr> <th>Schalleistungspegal LWAd, B</th> <th>Schalldruckpegal LpAm, dBA</th> </tr> </thead> <tbody> <tr> <td>EN27779<sup>3</sup></td> <td>—</td> </tr> <tr> <td>DSRVZ</td> <td>4,7</td> </tr> <tr> <td>DSRVZ + DEHUM</td> <td>—</td> </tr> </tbody> </table>	Leerlauf/Betrieb		Schalleistungspegal LWAd, B	Schalldruckpegal LpAm, dBA	EN27779 <sup>3</sup>	—	DSRVZ	4,7	DSRVZ + DEHUM	—	<table border="0"> <thead> <tr> <th colspan="2">Leerlauf/Betrieb</th> </tr> <tr> <th>Schalleistungspegal LWAd, B</th> <th>Schalldruckpegal LpAm, dBA</th> </tr> </thead> <tbody> <tr> <td>—</td> <td>—</td> </tr> <tr> <td>5,1</td> <td>37</td> </tr> </tbody> </table>	Leerlauf/Betrieb		Schalleistungspegal LWAd, B	Schalldruckpegal LpAm, dBA	—	—	5,1	37
Leerlauf/Betrieb																				
Schalleistungspegal LWAd, B	Schalldruckpegal LpAm, dBA																			
EN27779 <sup>3</sup>	—																			
DSRVZ	4,7																			
DSRVZ + DEHUM	—																			
Leerlauf/Betrieb																				
Schalleistungspegal LWAd, B	Schalldruckpegal LpAm, dBA																			
—	—																			
5,1	37																			

<sup>1</sup> For high altitude sites, decrease the operating temperature specification by 1.8° C (35.2°F) for each 1000 m (3200 ft).

<sup>2</sup> Current values for specific configurations are available from Digital Equipment representatives. 1 B = 10 dBA.

<sup>3</sup> Aktuelle Werte für spezielle Ausrüstungsstufen sind über die Digital Equipment Vertretungen erhältlich. 1 B = 10 dBA.

## Associated Documents

<i>DEChub 900 MultiSwitch Owner's Manual</i>	Provides installation, use, security, and troubleshooting information.
<i>DEChub ONE Installation</i>	Provides installation and operation guidelines for single-slot hub configuration, including rack-mount options and cabling.
<i>DECserver Network Access Software Installation (VMS)</i>	Describes how to install the network access server software onto VMS systems.
<i>DECserver Network Access Software Installation (ULTRIX)</i>	Describes how to install the network access server software onto ULTRIX systems.
<i>DECserver Network Access Software Installation (UNIX)</i>	Describes how to install the network access server software onto UNIX systems.
<i>Network Access Server Management manual</i>	Provides the procedures to perform management tasks for the various network access servers.
<i>Network Access Server Commands manual</i>	Describes the usage and syntax of commands for the various network access servers.
<i>Network Access Server Problem Solving manual</i>	Describes problem-solving tools and procedures for the various network access servers.